

- Komponentenliste:
- 1: Hauptschalter
  - 2: Transformator 400/230V~
  - 3: Steuersicherung 2,0A
  - 4: Schütz K1 Uc:230V~
  - 5: Bremsplatte 87085100
  - 6: Überlastschutz M...A
  - 7: Taster "Aus"
  - 8: Taster "Ein"
  - 9: Motor

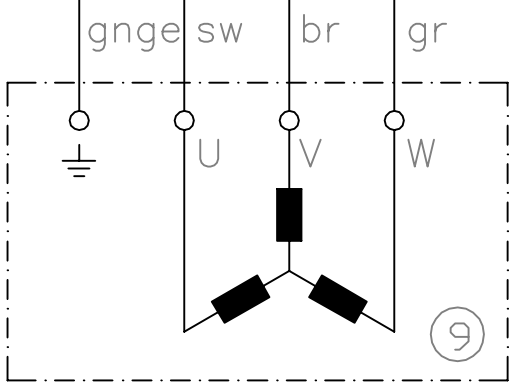
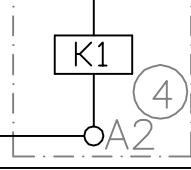
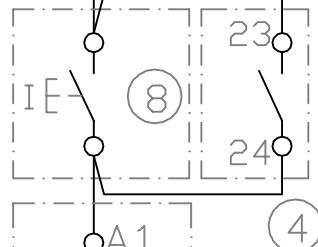
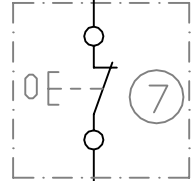
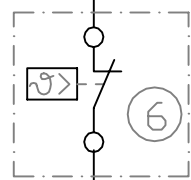
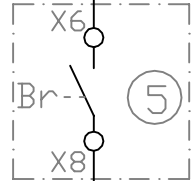
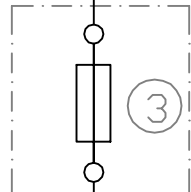
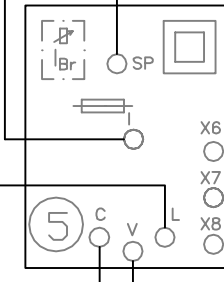
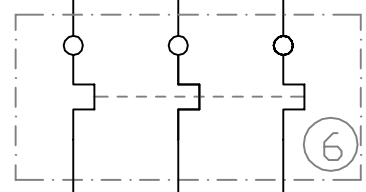
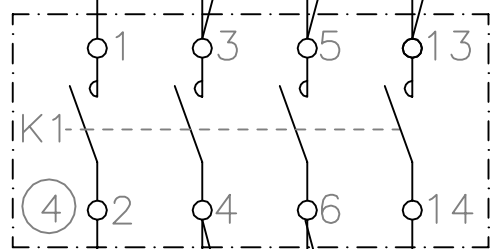
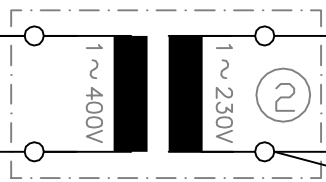
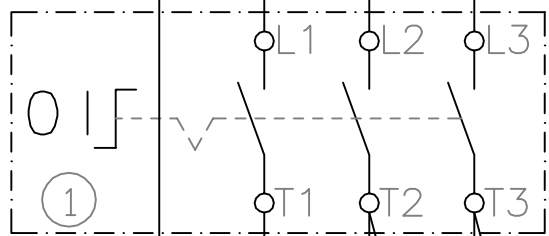

		Tag	Name	Bezeichnung
Bearb.	20.09.2010	M.Orlik	Aufschaltbremse 16eff	
Gepr.	20.09.2010	Treusch		
<b>KLINGER BORN</b>				ZgNr. e_16eff_400V_Trafo.dwg
Ind.	Änderung	Tag	Name	